

# HELOX

## Keyless Access For Secure Self-Storage



The HELOX padlock offers self-storage operators and tenants an easy-to-use, almost impenetrable layer of protection for stored items and to maintain facility integrity. Designed to integrate with tenant-facing mobile application EasyCode and operator-facing mobile application StorLogix Mobile, the PTI HELOX padlock enhances keyless protection with no disruption to current access control systems while protecting vacant lots from improper usage.



### DIGITAL KEY SHARING

Easily grant access to another individual for a specified period through the StorLogix Mobile and EasyCode apps



### ROBUST CONSTRUCTION

IP 68 grade, case-hardened steel chassis provides a dust-proof & waterproof lock that operates in temperatures of -25°C to 60°C for the most demanding environments



### INTEGRATED & CONNECTED

Bluetooth connectivity with a range of 50m, the HELOX integrates seamlessly with any smart device while connecting to the PTI platform for central control









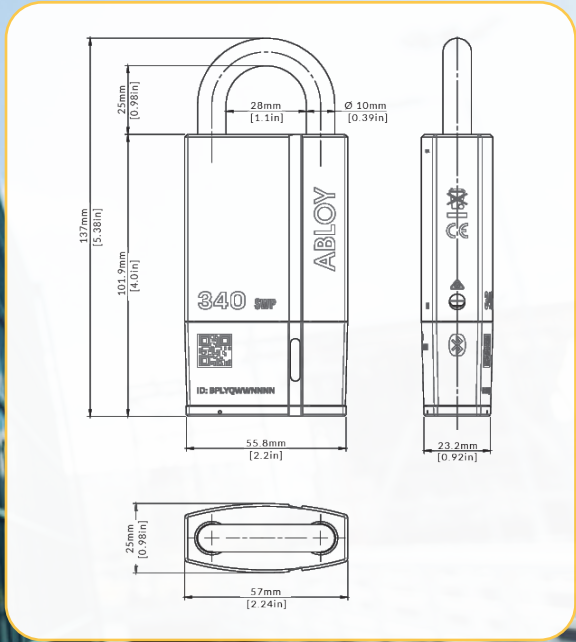

### CONTACT-LESS RENTALS

With HELOX, operators can provide tenants with a fully automated rental process for true 24/7 contact-less rentals

*“The changing demographics in storage unit tenants and the demand for simplified shareable key offerings require solutions that provide both elevated security and user convenience.”*

**NATHAN DAVENPORT** | Chief Technology Officer  
PTI Security Systems



	Chassis	<ul style="list-style-type: none"> <li>Material: Case-hardened steel</li> <li>Finish: Chrome</li> </ul>
	Shackle	<ul style="list-style-type: none"> <li>Material: Case-hardened steel</li> <li>Finish: Chrome</li> <li>Thickness: 10mm</li> </ul>
	Operating Temperature	<ul style="list-style-type: none"> <li>-25°C to 60°C</li> </ul>
	Security Grade	<ul style="list-style-type: none"> <li>EN16864 grade 4</li> </ul>
	IP Class Grade	<ul style="list-style-type: none"> <li>IP68</li> </ul>
	Battery	<ul style="list-style-type: none"> <li>5 years or 5000 access cycles</li> <li>Battery type: Saft LSI 14250</li> <li>3.6V Primary Lithium-Thyionyl Chloride, High energy density</li> <li>Back up power through USB cable</li> <li>Has a wide operating range - (-76°F to + 185°F)</li> <li>Suitable for all environments</li> </ul>
	Connectivity	<ul style="list-style-type: none"> <li>Bluetooth BLE 4.2</li> <li>Range up to 50m</li> </ul>
	Monitoring	<ul style="list-style-type: none"> <li>LED indications for lock status</li> <li>Audit logs</li> </ul>